

**Broncho-Oesophagoskopie**  
**Bronchoskopie-Optiken, autoklavierbar**

**Broncho-Esophagoscopy**  
**Bronchoscopy Telescopes, autoclavable**



**100-604-000**

Weitwinkel-Geradeausblick-Optik 0°, 4 mm ø,  
 Nutzlänge 30 cm, autoklavierbar

Straight Forward Wide Angle Telescope 0°, 4 mm ø,  
 working length 30 cm, autoclavable

**100-604-030**

Weitwinkel-Vorausblick-Optik 30°, 4 mm ø,  
 Nutzlänge 30 cm, autoklavierbar

Forward-Oblique Wide Angle Telescope 30°, 4 mm ø  
 working length 30 cm, autoclavable

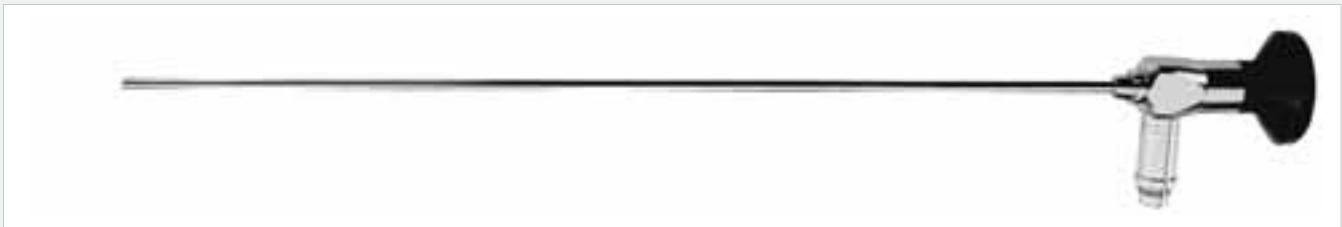

**100-627-000**

Weitwinkel-Geradeausblick-Optik 0°, 2.7 mm ø  
 Nutzlänge 27 cm, autoklavierbar

Straight Forward Wide Angle Telescope 0°, 2.7 mm ø  
 working length 27 cm, autoclavable

**100-627-030**

Weitwinkel-Vorausblick-Optik 30°, 2.7 mm ø  
 Nutzlänge 27 cm, autoklavierbar

Forward-Oblique Wide Angle Telescope 30°, 2.7 mm ø  
 working length 27 cm autoclavable

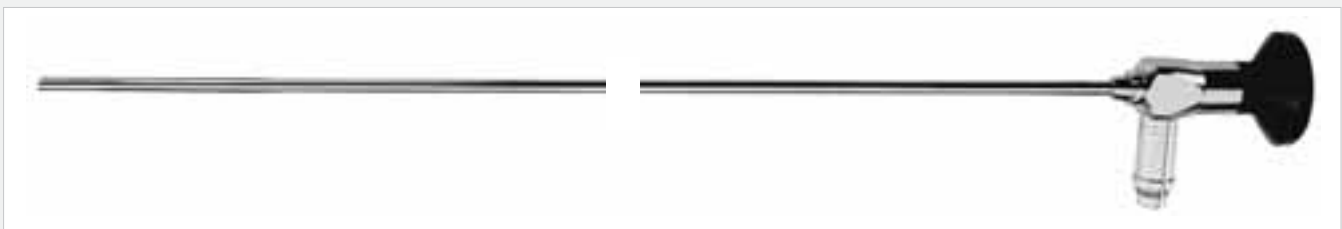

**100-655-000**

Weitwinkel-Geradeausblick-Optik 0°, 5.5 mm ø  
 Nutzlänge 50 cm, autoklavierbar

Straight Forward Wide Angle Telescope 0°, 5.5 mm ø  
 working length 50 cm, autoclavable

**100-655-030**

Weitwinkel-Vorausblick-Optik 30°, 5.5 mm ø  
 Nutzlänge 50 cm, autoklavierbar

Forward-Oblique Wide Angle Telescope 30°, 5.5 mm ø  
 working length 50 cm, autoclavable

**Broncho-Oesophagoskopie**  
**Broncho-Oesophagoskopiezangen**

**Broncho-Esophagoscopy**  
**Broncho-Esophagosopic Forceps**



100-750-301 - 100-750-610

Jackson Broncho-Oesophagoskopie-Zangen und Biopsiezangen mit Schienenschaft, obere Maulteile beweglich

Jackson Broncho-Esophagosopic Forceps and Biopsy-Forceps with standard-shaft, upper jaws moveable

	Schaft Ø shaft diameter	Schaftlänge / shaft-length			
		30 cm / 12"	40 cm / 15 3/4"	50 cm / 20"	60 cm / 23 1/2"
	ø 4 mm	100-750-301	100-750-401	100-750-501	100-750-601
	ø 4 mm	100-750-302	100-750-402	100-750-502	100-750-602
	ø 4 mm	100-750-303	100-750-403	100-750-503	100-750-603
	ø 2 mm	100-750-304	100-750-404	100-750-504	100-750-604
	ø 4 mm	100-750-305	100-750-405	100-750-505	100-750-605
	ø 2 mm	100-750-306	100-750-406	100-750-506	100-750-606
	ø 4 mm	100-750-307	100-750-407	100-750-507	100-750-607
	ø 4 mm	100-750-308	100-750-408	100-750-508	100-750-608
	ø 4 mm	100-750-309	100-750-409	100-750-509	100-750-609
	ø 4 mm	100-750-310	100-750-410	100-750-510	100-750-610

**Broncho-Oesophagoskopie**  
**Laryngo-Broncho-Oesophagoskopiezangen**

**Broncho-Esophagoscopy**  
**Laryngo-Broncho-Esophagoscopic Forceps**



100-720-401 - 100-720-613

100-720-301 - 100-720-313

Broncho-Oesophagoskopiezangen, Rohrschaft 2,5 mm ø  
Broncho-Esophagoscopic Forceps, tubular shaft, 2.5 mm ø

Laryngoskopie und Kinder-Bronchoskopiezangen,  
Rohrschaft, 2,0mm ø  
Laryngoscopy and Children Bronchoscopy Forceps,  
tubular shaft, 2.0 mm ø

Schaftstärke / Shaft diameter 2.5 mm

Schaftstärke / Shaft diameter 2.0 mm

Schaftlänge/shaft-length

Schaftlänge/shaft-length

40 cm / 15 3/4"

50 cm / 20"

60 cm / 23 1/2"

35 cm / 1 3/4"



100-720-401

100-720-501

100-720-601



100-720-301

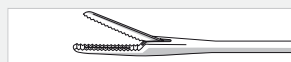

100-720-402

100-720-502

100-720-602



100-720-302



100-720-403

100-720-503

100-720-603



100-720-303



100-720-404

100-720-504

100-720-604



100-720-304



100-720-405

100-720-505

100-720-605



100-720-305



100-720-406

100-720-506

100-720-606



100-720-306



100-720-407

100-720-507

100-720-607



100-720-307



100-720-408

100-720-508

100-720-608



100-720-308



100-720-409

100-720-509

100-720-609



100-720-309



100-720-410

100-720-510

100-720-610



100-720-310



100-720-411

100-720-511

100-720-611



100-720-311



100-720-412

100-720-512

100-720-612



100-720-312



100-720-413

100-720-513

100-720-613



100-720-313



100-720-001 - 100-720-034

Bronchoskopiezangen, beide Maulteile beweglich  
Bronchoscopic Forceps, double-action jaws

		Schaft Ø shaft diameter	Schaftlänge/shaft-length		
			25 cm/10"	35 cm/13 3/4"	55 cm/21 1/2"
	Fremdkörperzange mit Hechtmaul Foreign Body Forceps alligator jaws	2,0 mm	100-720-001	100-720-011	----
	Universal Biopsie- und Faßzange Universal Biopsy and Grasping Forceps	2,0 mm	100-720-002	100-720-012	----
	Löffelzange, rund, gerade Biopsy Cup Forceps, straight, round cup	2,0 mm	100-720-003	100-720-013	----
	Faßzange mit gefenstertem Maul Grasping Forceps with fenestrated jaws	2,0 mm	100-720-004	100-720-014	----
	Fremdkörperzange mit Hechtmaul Foreign Body Forceps alligator jaws	2,5 mm	----	100-720-021	100-720-031
	Universal Biopsie- und Faßzange Universal Biopsy and Grasping Forceps	2,5 mm	----	100-720-022	100-720-032
	Löffelzange, rund, gerade Biopsy Cup Forceps, straight, round cup	2,5 mm	----	100-720-023	100-720-033
	Faßzange mit gefenstertem Maul Grasping Forceps with fenestrated jaws	2,5 mm	----	100-720-024	100-720-034

**Broncho-Oesophagoskopie**  
Zubehör für Bronchoskopie

**Broncho-Esophagoscopy**  
Accessories for Bronchoscopy

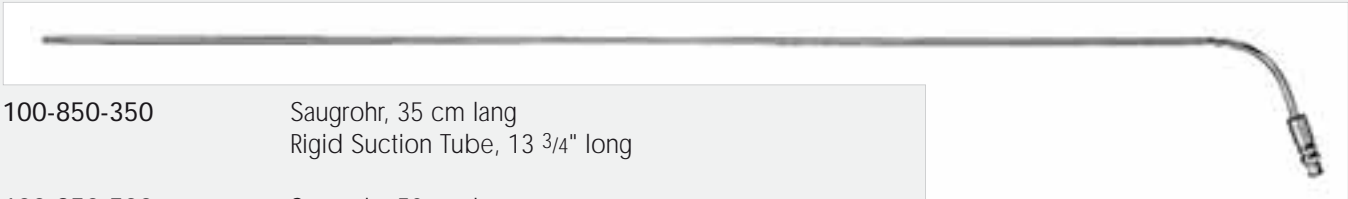

100-850-350 Saugrohr, 35 cm lang  
Rigid Suction Tube, 13 3/4" long

100-850-500 Saugrohr, 50 cm lang  
Rigid Suction Tube, 20" long

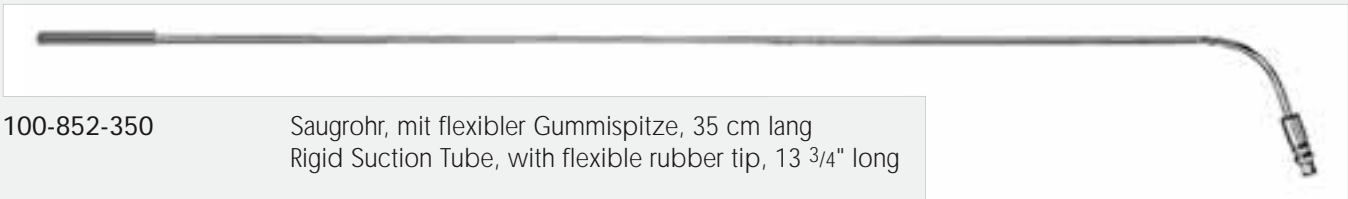

100-852-350 Saugrohr, mit flexibler Gummispitze, 35 cm lang  
Rigid Suction Tube, with flexible rubber tip, 13 3/4" long

100-852-500 Saugrohr, mit flexibler Gummispitze, 50 cm lang  
Rigid Suction Tube, with flexible rubber tip, 20" long



100-854-350 Watteträger, Nutzlänge 35 cm  
Cotton Carrier, working length 13 3/4"

100-854-500 Watteträger, Nutzlänge 50 cm  
Cotton Carrier, working length 20"



100-856-380 Tupferhalter, 1 x 2 Zähne, 38 cm Nutzlänge  
Sponge Holder, 1 x 2 teeth, 15" working length



100-868-100 Frankenfeld  
Laryngeal-Schnürer, Nutzlänge 31 cm / 12 1/4" / Laryngeal-snare, working length 31 cm / 12 1/4"

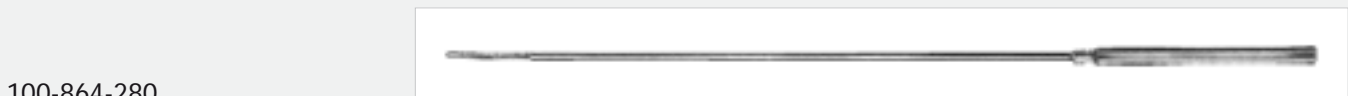

100-864-280 Watteträger, spiralförmig gerieft, 2,5 mm ø, Länge 28 cm / 11"  
Cotton applicator, twist end serrated, 2,5 mm ø, length 28 cm / 11"

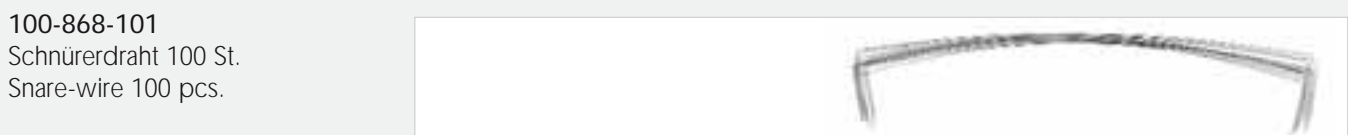

100-868-101 Schnürerdraht 100 St.  
Snare-wire 100 pcs.

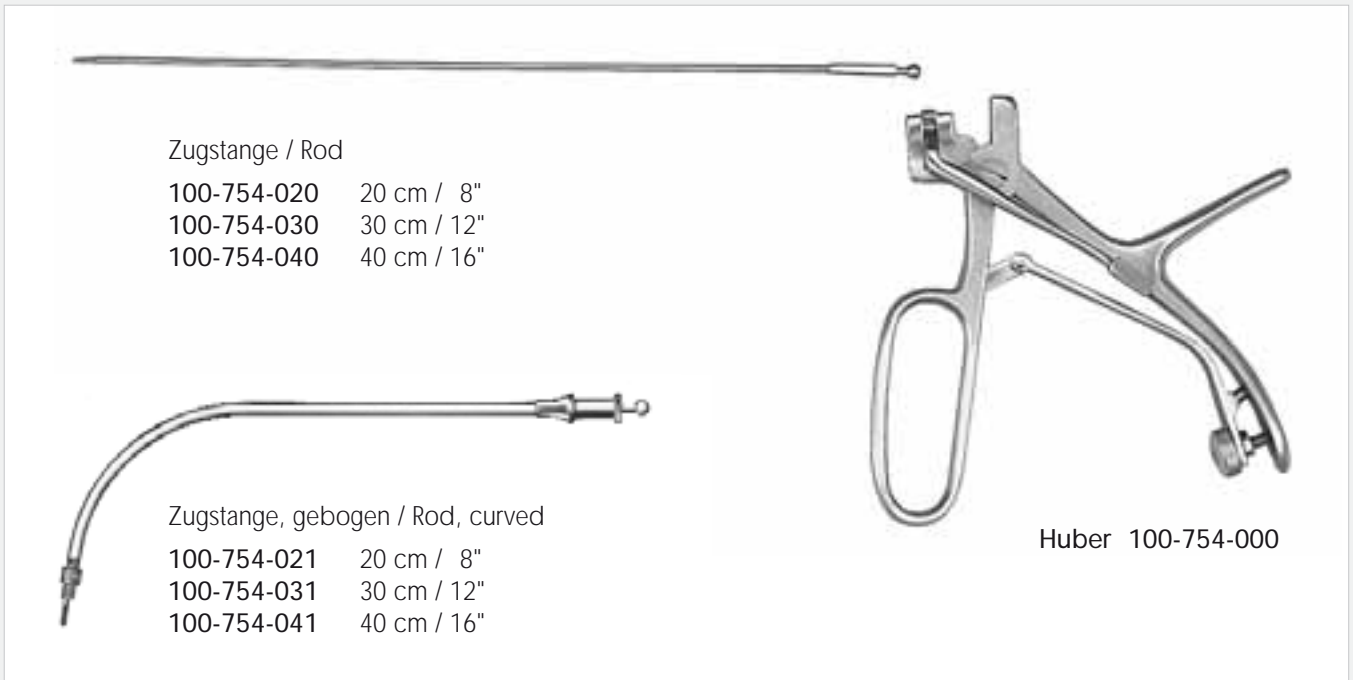

## Aufsätze / Jaw tip

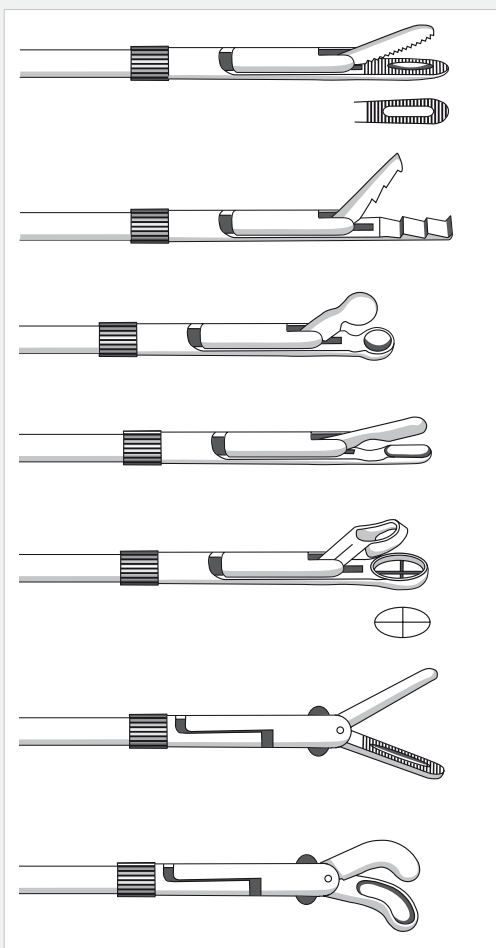

- 100-754-002 Faßzange / Grasping Forceps
- 100-754-003 Hechtmal / Alligator jaw
- 100-754-004 Löffelmal, runder Löffel / Cupped jaw, round cup
- 100-754-005 Löffelmal, ovaler Löffel / Cupped jaw, oval cup
- 100-754-008 ovaler Löffel / Cupped Punch, oval cup
- 100-754-010 Faßzange doppelbeweglich / Grasping Forceps, double action
- 100-754-012 Löffel doppelbeweglich / Cupped jaw, double action

## Doppelbewegliche Löffel und Faßzangen

## Double-action Cupped and Grasping Forceps



Chevalier-Jackson

### Doppelbeweglich / Double-action

#### Hechtmaul / Alligator jaw

100-755-305	Länge / Length	30 cm / 12"
100-755-405	Länge / Length	40 cm / 15 3/4"
100-755-505	Länge / Length	50 cm / 20"
100-755-605	Länge / Length	60 cm / 23 1/2"

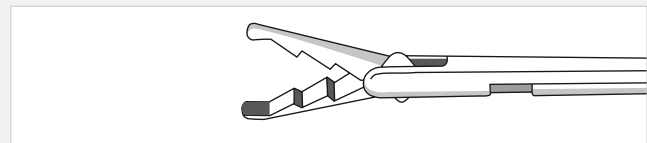

#### Faßzange, gerieftes Maul / Grasping Forceps, serrated jaw

100-755-304	Länge / Length	30 cm / 12"
100-755-404	Länge / Length	40 cm / 15 3/4"
100-755-504	Länge / Length	50 cm / 20"
100-755-604	Länge / Length	60 cm / 23 1/2"

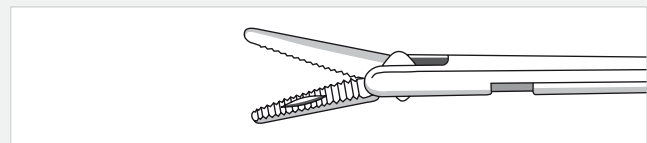

#### Löffelzange / Cupped Forceps

100-755-310	Länge / Length	30 cm / 12"
100-755-410	Länge / Length	40 cm / 15 3/4"
100-755-510	Länge / Length	50 cm / 20"
100-755-610	Länge / Length	60 cm / 23 1/2"

